



4 way Power Divider

PD-6727-050-04N

Specifications:

Frequency Range:	670-2700 MHz
Insertion Loss:	6.5 dB Max
Isolation:	20 dB Min
VSWR:	1.3:1 Max
Power:	50 Watts
Impedance:	50 Ohms
Connectors:	N female
Operating Temp. Range:	-35°C to +60°C
Relative Humidity:	5% - 95%

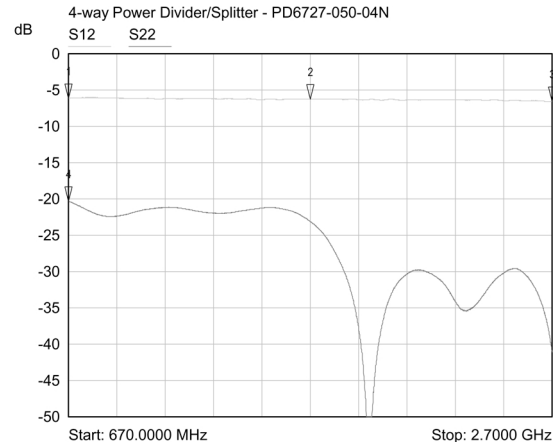
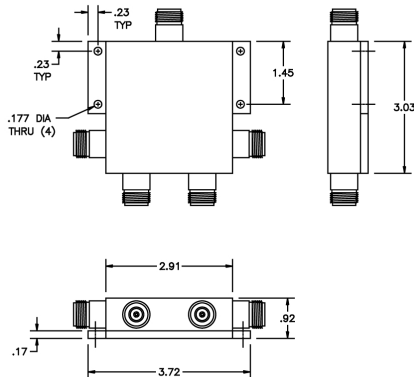

MICROWAVE FILTER CO., INC.
6743 KINNE STREET, E. SYRACUSE, NY 13057
E-Mail: mfcsales@microwavefilter.com

800-448-1666 • 315-438-4700
Web: www.microwavefilter.com