



30 dB/10W Attenuator

AR-0030-010-30NF

Specifications:

Frequency Range:	DC-3 GHz
VSWR:	1.20:1 Max
Power:	10 Watts Avg
Attenuation:	30 dB, ± 1.0 dB
Impedance:	50 Ohms
Connectors:	N female, N male
Operating Temp. Range:	-20°C to +85°C

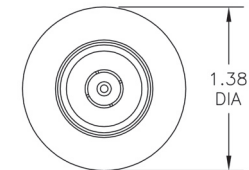
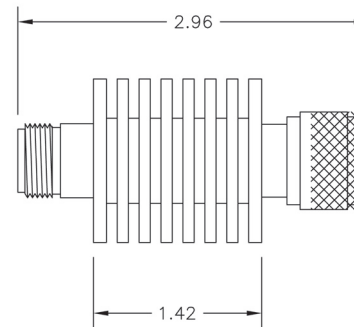
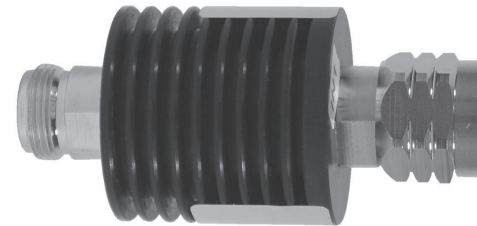

MICROWAVE FILTER CO., INC.
6743 KINNE STREET, E. SYRACUSE, NY 13057
E-Mail: mfcsales@microwavefilter.com

800-448-1666 • 315-438-4700
Web: www.microwavefilter.com